

User Guide

Contents

Overview	3
Measure iOS Application	3
Measure Receiver.....	4
Measure Online Environment	5
Your Quick-Start Guide	6
Icon Library	7
Settings	8
Using LoopLink	9
Test Signals	9
Field Strength / Current Control	10
Frequency Response / MLC Control	10
What and how to measure	11
Service Points, Counters and Localised Small Volume Systems	11
Area Coverage Systems	12
How to Measure.....	13
Meter Mode	14
Meter Mode - Field Strength.....	15
Meter Mode - Frequency Response.....	16
Meter Mode - Background Noise.....	17
Getting Started: Setting up a project in the App	18
Test Mode.....	19
Test Mode - Commissioning Test	20
Test Mode - Commissioning Test results in the Loopworks portal.....	22
Test Mode - Commissioning Test Reporting in the Loopworks portal.....	23
Test Mode - Quick Check Test	24
Test Mode - Quick Check Test Results in the Loopworks portal.....	25
Test Mode - Freestyle Test.....	26
Test Mode - Site Assessment Test.....	28
Test Mode - Site Assessment Test Results in the Loopworks Portal.....	29
Test Mode: Editing a Project or System in the Portal.....	30
Verdicts.....	31
Listening Mode.....	33
Trouble Shooting.....	33
Important Safety Information	34

Overview

The Loopworks Measure tools consist of three parts; an iOS App, an R2 Receiver and the online portal. The App can be used in a simple **Meter mode** to replicate the functionality of a traditional field strength meter but provides significantly increased functionality when signed in to a free Loopworks account.

A Loopworks account enables enhanced test meters, direct driver control via LoopLink, recording audio samples and **Test mode**, which contains step-by-step wizards to guide you through different procedures with immediate system verdict feedback.

All test data is synchronised with the Loopworks™ online portal when the device connects to a wireless network, which allows analysis of results and creation of reports and certificates.

Your Loopworks account also allows access to other areas of the online portal, including the hearing loop design tool and on demand, accredited training courses.

Loopworks™ Measure iOS Application

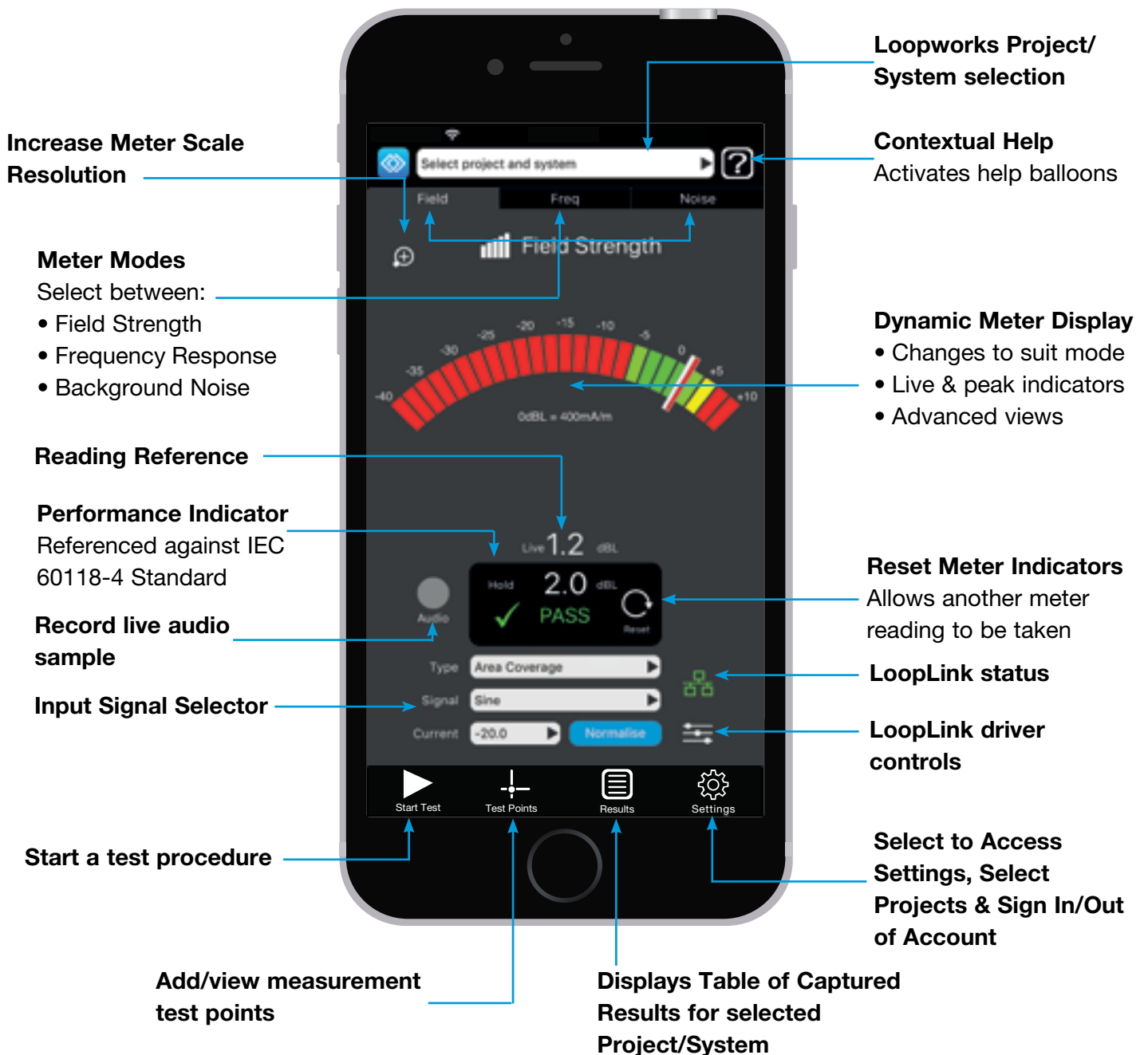

Loopworks™ Measure Receiver

To use the Loopworks App you will also need an R2 Receiver, which can be purchased from the Ampetronic website or your local distributor. The Receiver has a 3.5mm jack that plugs into the headphone socket on your iOS device. An official Apple headset adapter is required to use the R2 Receiver with either Lightning or USB-C devices.

WARNING: For important information about avoiding hearing loss, see Important safety information at the back of this User Guide.



3.5mm (1/8 inch) Jack plugs into top or bottom headphone socket on iOS device



Headphones with standard 3.5mm (1/8 inch) jack can be plugged into the Receiver



Alignment!

NOTE: When taking a meter reading in any mode it is essential that the device is held vertically at the intended listening height to simulate the position of the telecoil in a hearing aid. Deviation of over 30° from vertical will result in an alignment warning symbol being displayed and data capture function being deactivated.

Loopworks™ Measure Online Environment

When you are signed into your Loopworks account, the App can synchronise your data with the Loopworks online portal, making it possible for you, or a colleague, to analyse the results online and create test and certification reports.

You can also set up systems and test points prior to going to site, playback recorded audio and get live support and analysis from our Ampetronic loop experts, by phone or live chat, when using the online Loopworks environment.

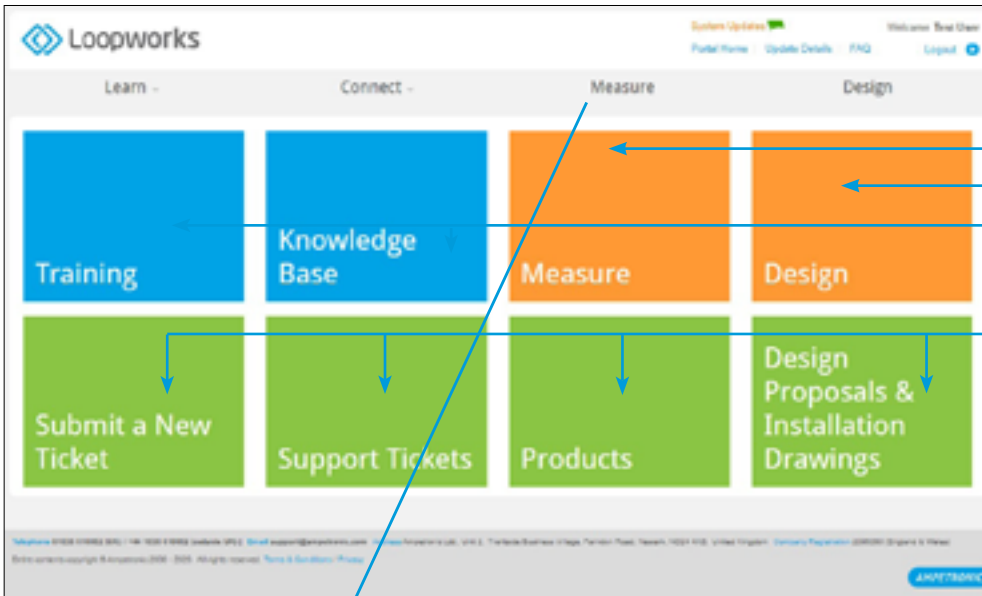

Navigate to resources and tools via the Loopworks portal homepage

- Loopworks Measure
- Loopworks Design
- Loopworks Learn
- Loopworks Connect

Loopworks Measure
See and share your projects, designs and measurements

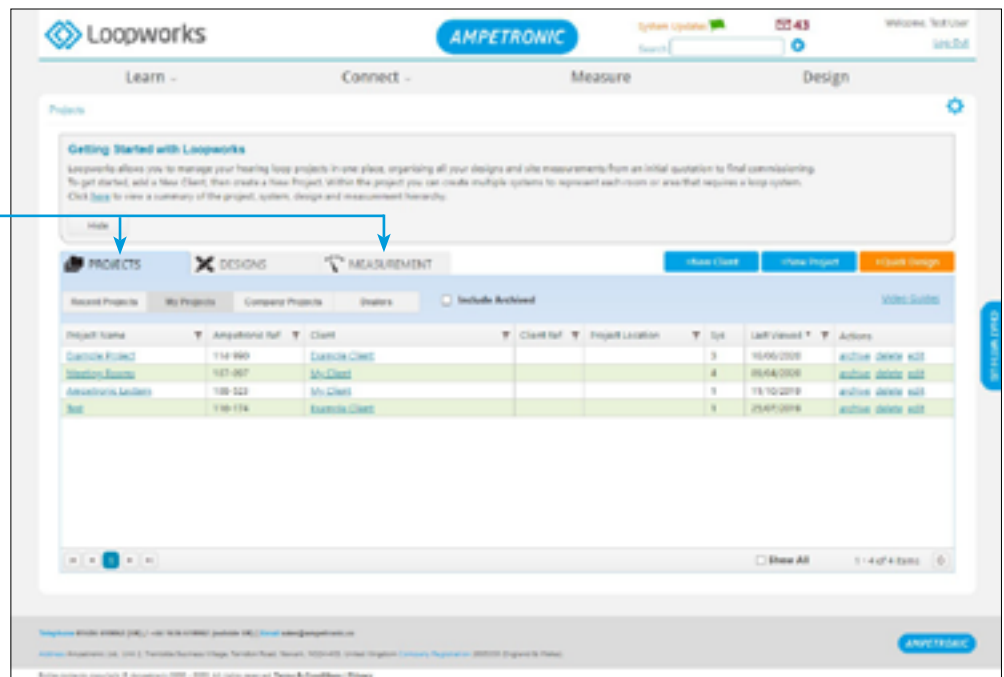

Your Quick-Start Guide

1. Purchase Receiver

You will need an R2 Receiver to perform any measurements in the app. The receiver contains a telecoil and enables your iOS device to accurately measure magnetic fields. You can purchase an R2 Receiver from the Ampetronic website or through your local distributor.

<https://www.ampetronic.com/products/loopworks-measure-receiver-field-strength-meter-R2/>



2. Sign up for Loopworks™

Create a free account to access the Loopworks online portal, and enable increased functionality on the App. This stage is optional, and you can use the App in simple meter mode; however, you will need an account to access the full range of functions and to be able to save data or record audio.

Create an account at loopworks.ampetronic.com or from within the app.

3. Download the FREE App

Visit the App Store on your iOS device and search for 'Loopworks Measure' to download the app for free. Note we recommend allowing automatic updates to ensure you get the latest features and improvements as soon as they are released.



4. Connect the Receiver . . .

Start your new App and plug the Receiver into the headphone socket of your iOS or via the lightning USB-C adaptor device to activate it.

Follow the on-screen instructions to allow access to the microphone and enter the label number (digits only) printed on the side of the Receiver.

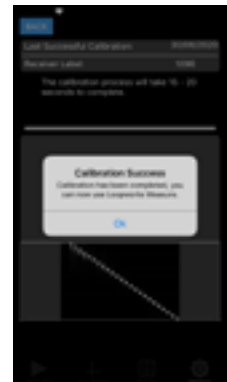
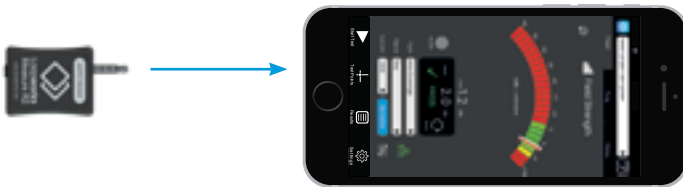

5. Then calibrate the Receiver









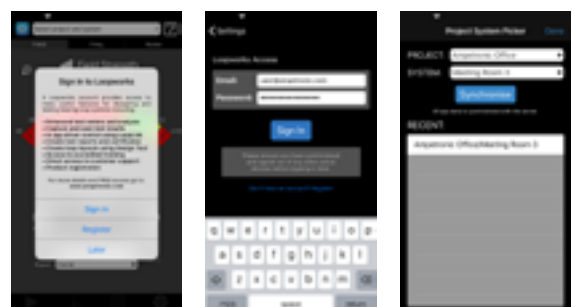













Follow the on-screen instructions to calibrate the receiver against your iOS device's settings. This is an important function to allow accurate meter readings to be taken.

6. Sign in to Loopworks

After successful calibration you will be prompted to sign in when first opening the app, if you have not already created an account you can register within the app at this stage. If you choose not to sign in now, you can sign in via the settings menu at any point. During sign in any existing data will be synchronised to the app, you can check the synchronisation status and manually synchronise at any point from the projects menu.

Note: Loopworks Measure only allows a user to be signed in to one device at a time. Multiple users should each create their own free Loopworks account. If using different devices, you must make sure your data is fully synchronised then logout of the first device before signing in to the second.



Icon	Meaning	Definition in Measure App
General Menu Items		
	Field Strength Meter	Measure un-weighted magnetic field strength in dBL (Ref: 0dBL = 400mA/m)
	Frequency Response Meter	Measure un-weighted frequency response of the magnetic field in dBL (Ref: 1 kHz)
	Background Noise Meter	Measure A-weighted magnetic field strength of unwanted signals in dBL (Ref: 0dBL = 400mA/m)
	Record	Record a live audio sample of the signal for record or review in the Loopworks web portal. NB this option is only possible when performing a test session.
	Save	Press to save a meter reading by assigning it to an individual test point.
	Reset	Press to erase the history of the peak level indicator.
	Results	Select to show a table of captured data for the selected project/system.
	Start Test	Use the Loopworks Measure App to access step-by-step guides/wizards for system commissioning tests, quick check tests, freestyle tests and site assessments.
	Stop Test	Stop or interrupt a certification test or site assessment; you can restart later.
	Test Points	Set-up and select a test point at a specific room location and height to take meter readings at. NB this option is required to save or record audio.
	Settings	Select to sign in to your Loopworks account, sync data, select/change projects and alter audio/device settings.
	Contextual Help	Toggles the help on and off. Menu items become inactive in the mode instead displaying a descriptive help balloon.
Test Types		
	Background Noise	Icon used to denote readings of unwanted electro-magnetic background noise in the Loopworks™ App, online tools and on certification reports
	Field Strength	Icon used to denote readings of magnetic field strength in the Loopworks™ App, online tools and certification reports.
	Frequency Response	Icon used to denote readings of frequency response in the Loopworks™ App, online tools and certification reports.
	Live Field Strength	Icon used to denote readings of live signal field strength in the Loopworks™ App, online tools and certification reports.
	System Noise	Icon used to denote readings of unwanted noise created by the installed loop system in the Loopworks™ App, online tools and certification reports.
	Overspill	Icon used to denote readings of unwanted magnetic field strength outside the required area in the Loopworks™ App, online tools and certification reports.
	Live Signal Listening Test	Icon used to denote a test where headphones have been used to physically listen to a live signal such as a voice or music using the Loopworks Measure app to replicate a hearing aid.
	Venue Accessibility	Icon used to denote whether staff have been trained to use the system and that a Hearing Loop sign is visible in the covered area and at each entry point.
Online Portal Menu		
	Projects	Review, edit or create a hearing Loop project in which to take Measurements or specify/design.
	Design	Review, edit or create a hearing Loop system specification and/or design.
	Measurements	Review measurement values for hearing loop systems surveyed using the Loopworks Measure App, or manually enter values for a system surveyed using a traditional Field Strength Meter.

Settings

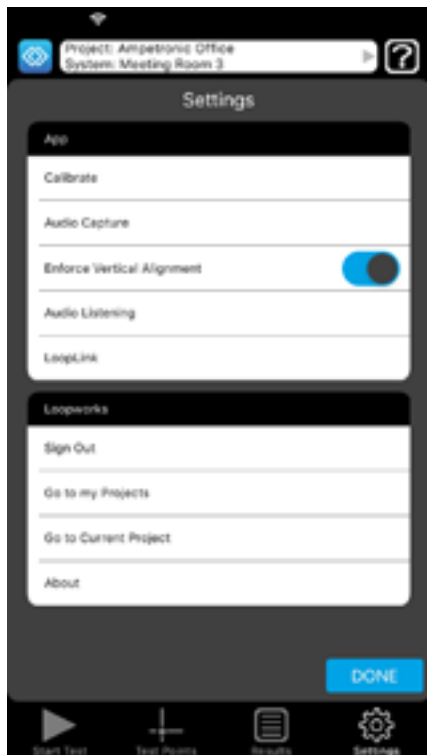

Settings Screen

Sign in/out, edit projects, check versions and alter your device preferences.

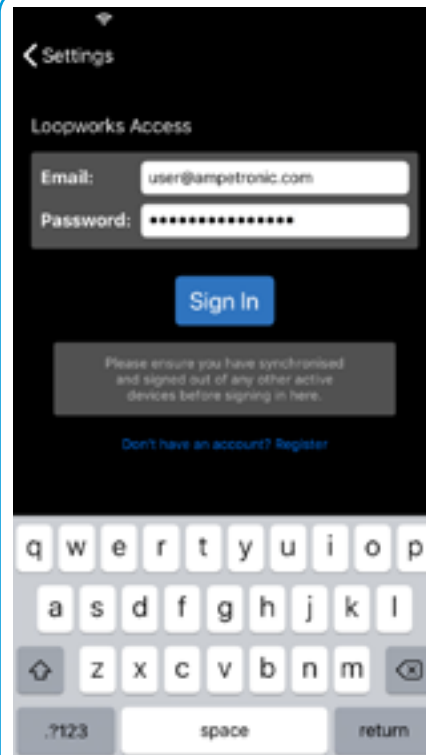

Sign in

Sign into your Loopworks account via the App.

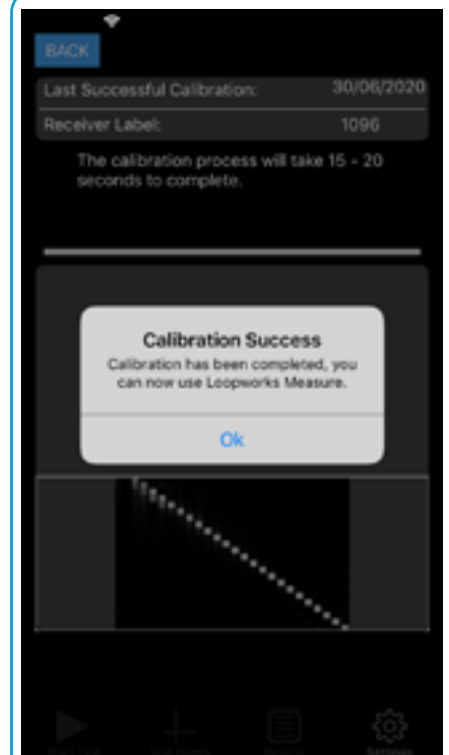

Calibrate Receiver

Review previous calibration results, manually recalibrate at regular intervals or if receiver changed.

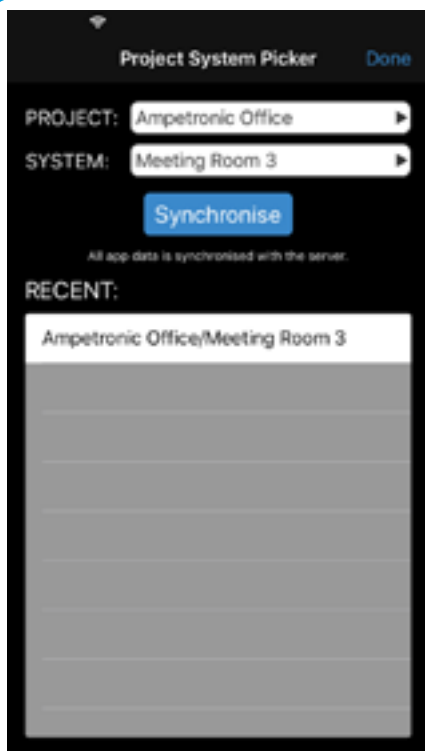

Projects

Select project and system, view recent or add new records.

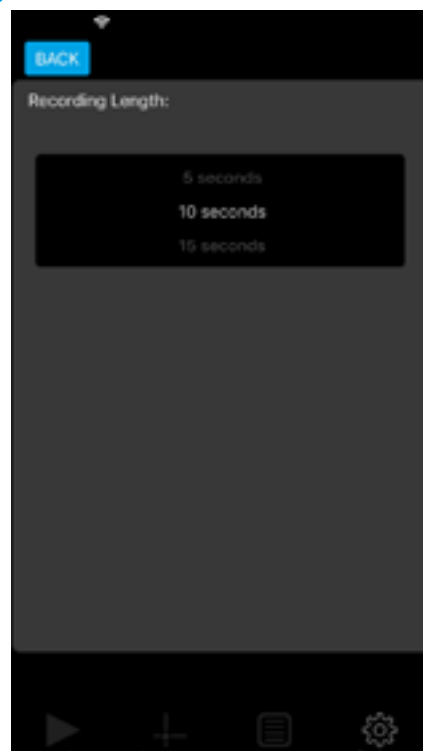

Audio Settings

Increase/decrease audio capture times.



About Measure App

Check App details and ensure that you have the most up to date version available.

Using LoopLink

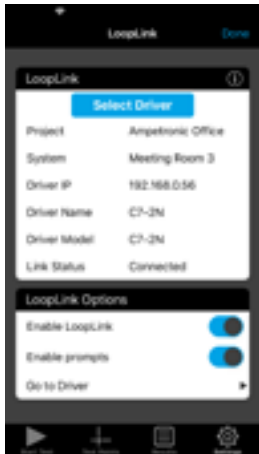

LoopLink enables direct connection from the Loopworks Measure App to any Ampetronic C, D or T Series network enabled driver, for automation of test signals and control of current and frequency response correction. This allows you to speed up testing by removing the need to return to the amplifier or switch between the app and web browser to update settings. With meters and controls in one place you can make precise level adjustments and get instant feedback on any changes made.

Note: You must be signed in to your Loopworks account to access the LoopLink features.

Access LoopLink settings either via the main settings menu or pressing the LoopLink icon on one of the meter views. From here you can select your driver by entering the IP address, this can normally be obtained from the front panel of the amplifier. Ensure your iOS device is connected to the same network as the amplifier before trying to connect. You will need to provide the username and password for the amplifier before you're able to connect, see the amplifier handbook for default credentials, if using a C-Series driver you must sign in as an audio or super administrator to use LoopLink.

Once connected you can manually disconnect if required or choose to completely forget the IP address and credentials of the amplifier.

The Link Status will update to reflect if connection has been lost to the amplifier, and this is also reflected by the colour of the LoopLink icon on the meter views (grey – not configured, green – connected, red – disconnected).

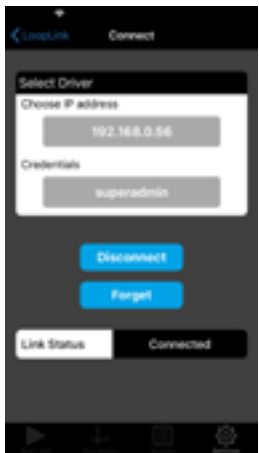

Test Signals

While LoopLink is connected the test signals built into the amplifier will be automatically controlled by the app. This means as soon as you change meter view the default test signal for that measurement will be activated on the amplifier and readings can be taken straight away. Manually changing the Signal selected in the app will also update the amplifier. This includes 'System Off' which completely disables the output section of the amplifier, allowing background noise readings to be carried out without physically turning off the power. If at any point you wish to turn off the test signals while still connected you can select the 'Signal Off' option. When disconnecting from an amplifier or closing the app, it will automatically turn off the test signals to ensure these are not left running when you have finished testing the system.

Selecting a different test signal directly on the amplifier will update the selection in the app, as long as it is a suitable signal for the current measurement mode. If the test signal selected is not suitable a pop-up warning will be displayed in Loopworks Measure.

LoopLink also provides direct access to key settings on the connected amplifier, which allow you to view the performance on the live meters, make accurate adjustments and see immediate feedback from the changes made in one place. These settings are available for field strength and frequency response views when in meter mode, or within commissioning, freestyle or site assessment test sessions. For more information on specific settings and options refer to the handbook for the amplifier.

Field Strength / Current Control

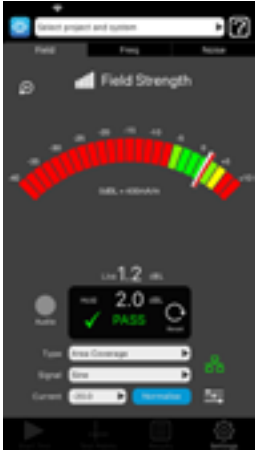

On a field strength view you can type in a precise numerical value for the output current, normalise the system or tap the sliders icon to open more options.

The sliders icon opens a window with one or two sliders depending on the amplifier connected. Single channel amplifiers will show a current slider, with a numerical field for entering precise values. Dual channel amplifiers will also show an offset control which allows a different output level to be set for each loop circuit or completely disable an output, depending which amplifier you are connected to.

Normalise takes the peak hold reading from the meter and adjusts the output current of the amplifier to achieve 0 dB field strength at that test position, if possible. Normalise may not work correctly if the existing field strength is very low, a minimum current of -20dB is recommended before using this feature.

Note that normalise will affect the field strength at all test points across the room and so invalidate previously saved readings. It is recommended to use this in one position and then check the rest of the test points to confirm they fall within ± 3 dB.

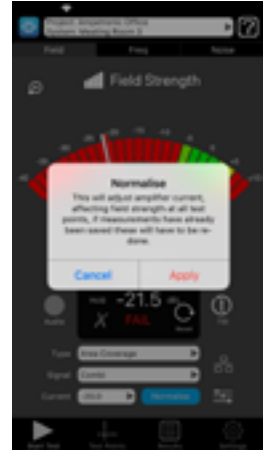

Frequency Response / MLC Control

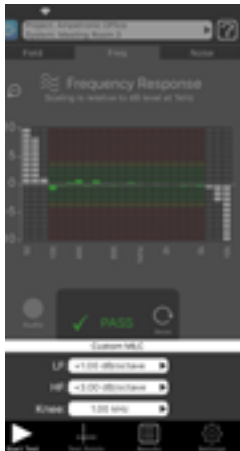
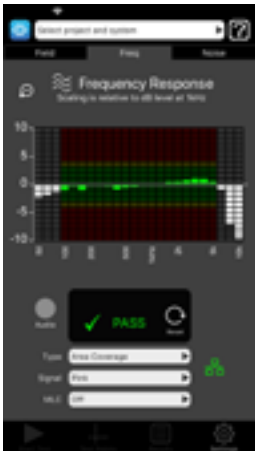

On frequency response views a dropdown allows choice of preset MLC slopes which allow you to correct for high frequency losses. If the response cannot be corrected with a preset slope then 'Custom' can be selected. Once selected, pressing the custom MLC icon shows a set of three dropdowns, to set the centre knee frequency, low frequency slope and high frequency slope independently.

LoopLink also allows you to associate amplifier connections with projects and systems in the app. This stores the IP address and credentials of the amplifier against the specific system, meaning the connection is restored whenever changing back to that system in the future. The connection is stored locally within the app and not synchronised to the online portal.



Whenever you have a system selected and connect to a driver in LoopLink settings, this connection will be saved against the current system.

Enabling prompts in the LoopLink settings makes it easier to use this feature. If you have an active LoopLink connection, when selecting a new system that has not previously had an amplifier saved to it, you will be asked if you wish to save the current amplifier details to that system. If LoopLink is not connected then you will be asked if you wish to configure a new connection to store against that system. To remove amplifier details that have been stored against a system, simply go to LoopLink settings and choose 'Forget' to wipe the IP address and credentials.

What and how to measure

The specification of a hearing loop system can seem complex, requiring detailed knowledge of all the necessary elements of the system, the loop design options available and their limitations, amplifier selection plus adherence to Standards. When starting the specification process, it is essential that the audio being transmitted, and any unwanted noise, are captured at the correct height and in multiple areas throughout the area to be covered. The listening plane is usually assumed to be at a height of 1.2m for a seated person or 1.7m standing.

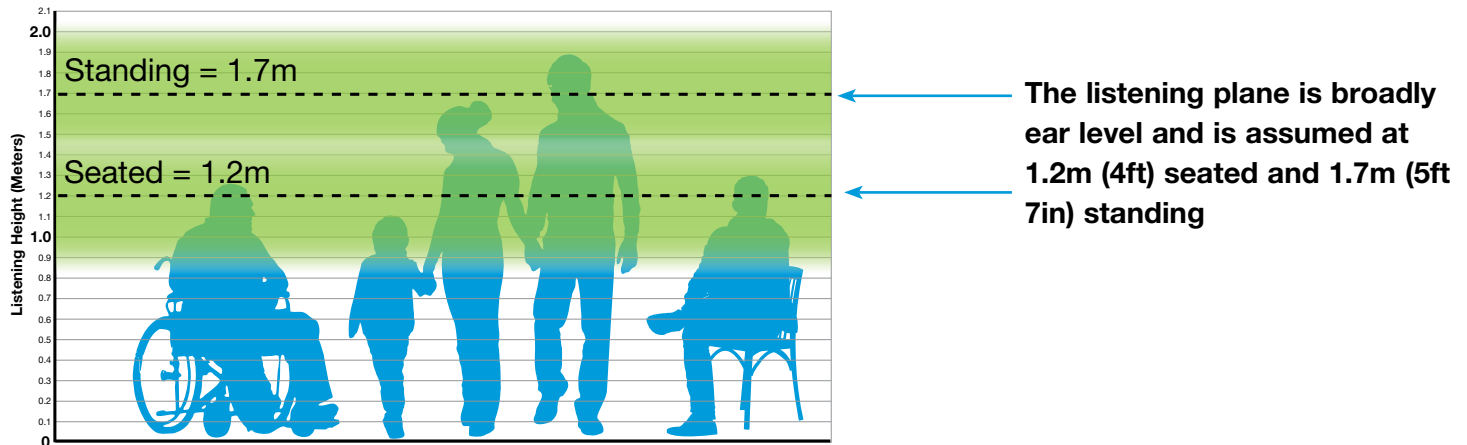

Service Points, Counters and Localised Small Volume Systems

Induction loops can also be used for one-to-one communications, such as at service counters, help points and intercoms. The height of the listening plane needs to be appropriate to the setting, and localised overspill will also need to be considered in order to maintain a consistent signal and confidentiality. Test at standing and seated heights to ensure the hearing aid receives a strong signal.

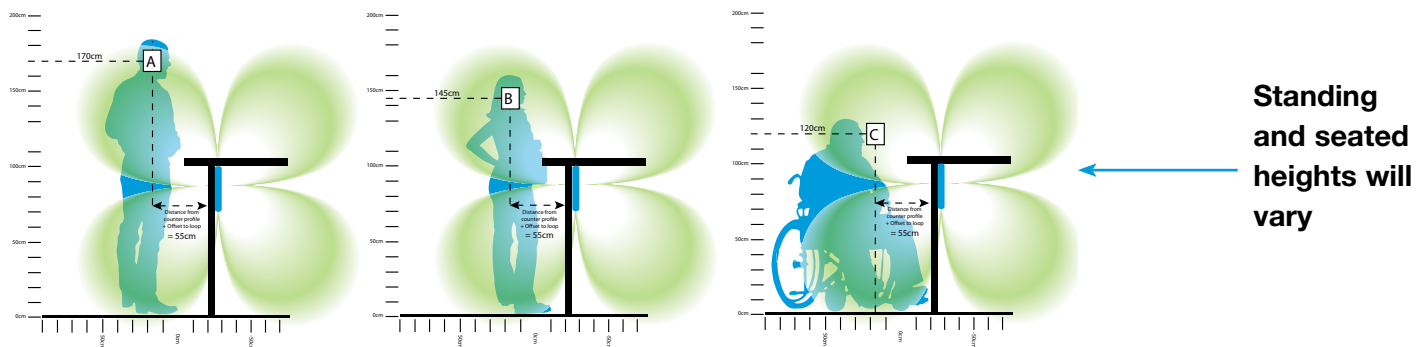

This diagram is a plan view of a service point (from above)

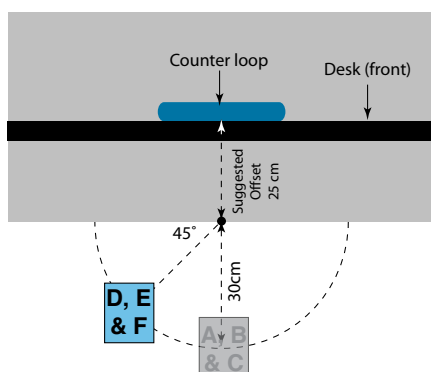

Measure at 45° off axis from the counter in addition to directly in front, to ensure some lateral movement is allowed for.

Area Coverage Systems

To ensure even and consistent loop coverage, define test points around the room or area to be looped, at the correct height for the room's main usage and spaced out evenly across the listening area.

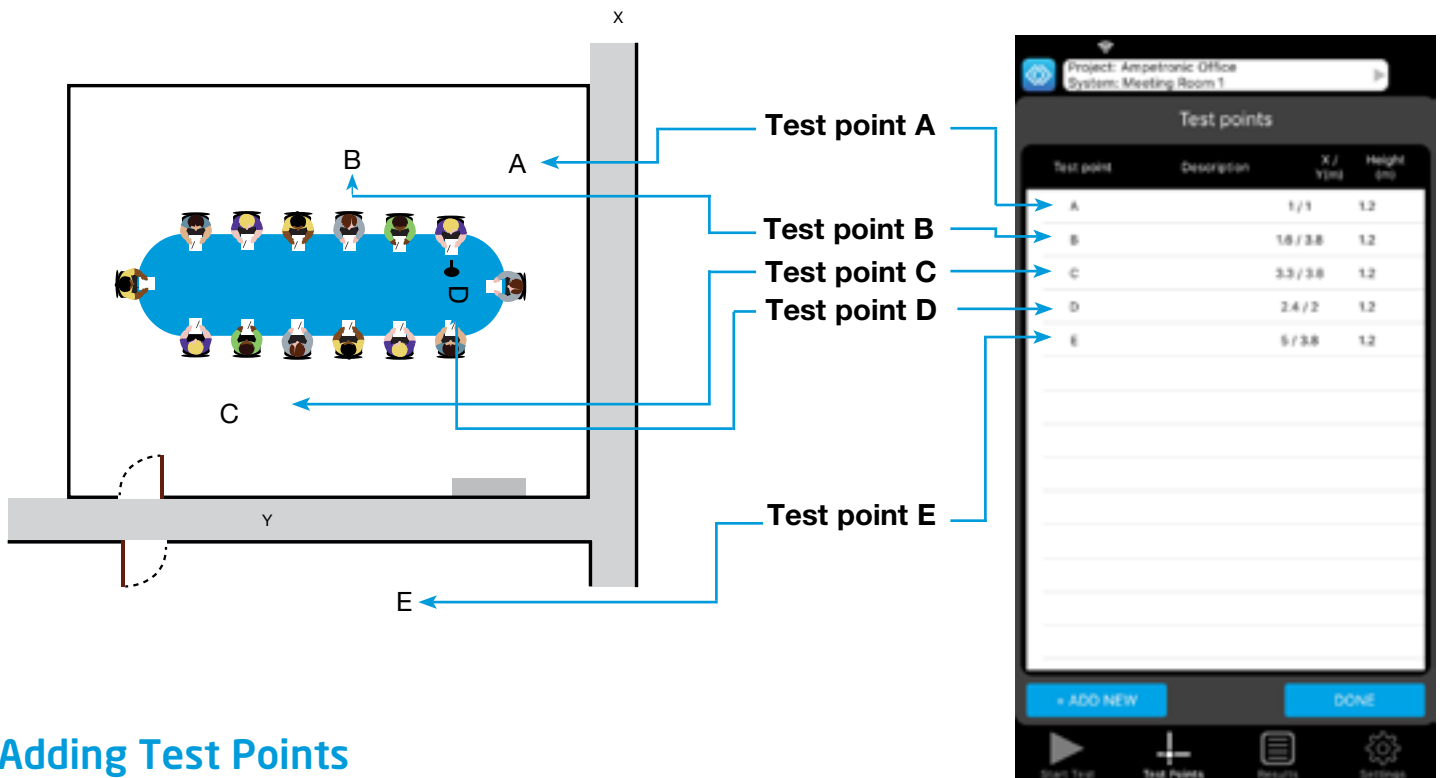

Adding Test Points



At least 4 test points are needed to create a system verdict, any overspill readings should be added as separate test points in addition to these.

Test points can be added individually, allowing a unique name, measurement height, X/Y co-ordinates and description for each position. Press 'Done' to add just that one test point, or to immediately add another press 'Save & Add More'.



You can also add batches of test points, this is useful when testing larger areas or when test point names can be referenced to a drawing. Select Batch mode at the top, you will then get a set of different fields. Prefix allows you to add a common name for each test point which will then have a number added. Height is fixed across all batch added test points, and you cannot specify X/Y co-ordinates. Choose a quantity of points up to 25 to create, if you are adding a second batch you can offset the start number. The list below will show the names of each test point that is going to be created based on your settings. As with the single option press 'Done' to finish or 'Save & Add More' if you need to continue adding test points.

How to Measure

The Loopworks Measure Receiver contains an internal Telecoil (T-Coil), mounted in an axis that replicates the vertical position in a standard hearing aid, when attached to a mobile device. The Receiver must be in the vertical position when you are taking measurements. Deviation of over 30° from vertical will result in an alignment warning symbol being displayed and the data capture function being deactivated.

NB. This feature can be deactivated using the 'Device Alignment' function in the settings menu if using an adapter for the receiver.

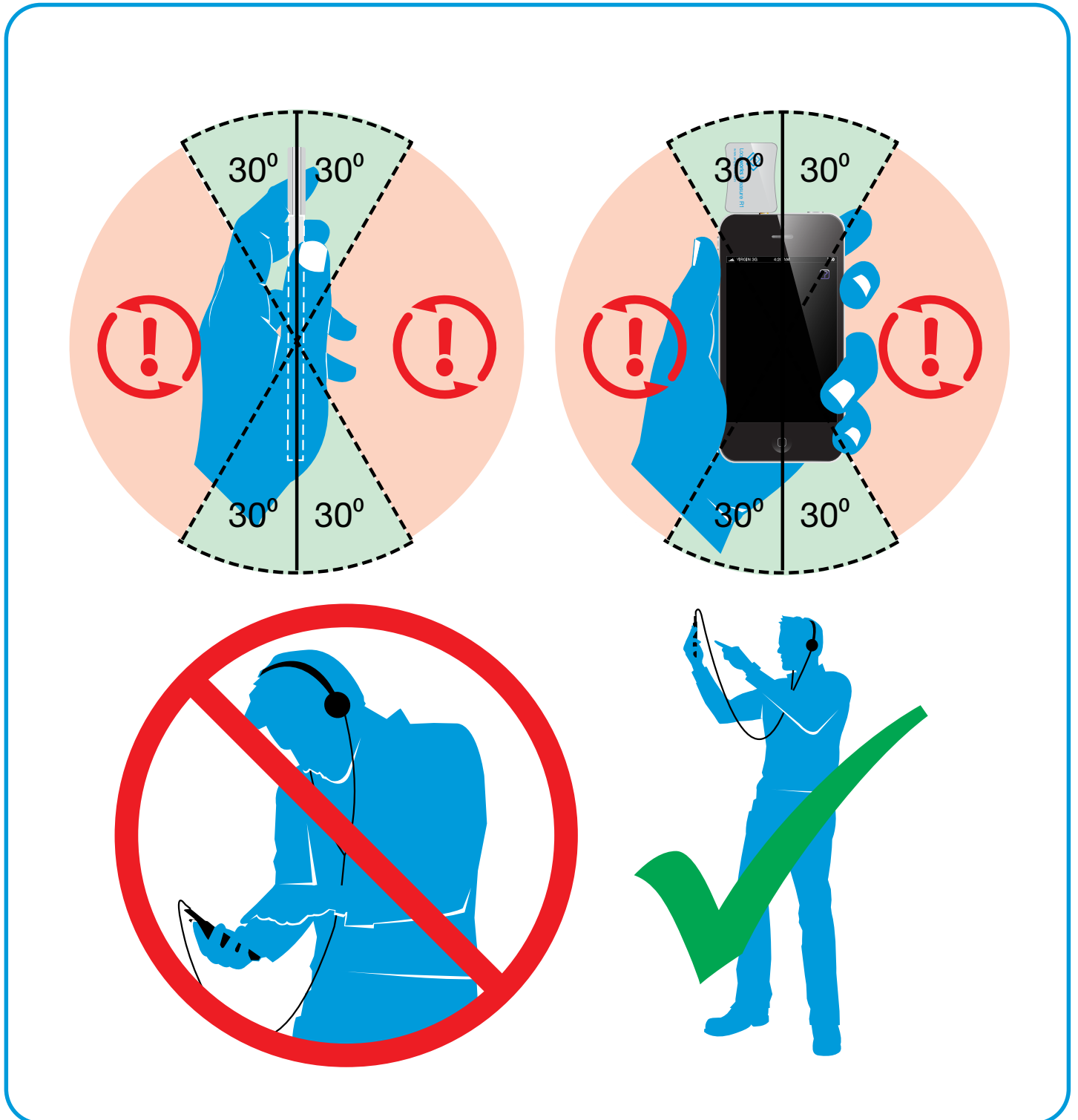

Meter Mode

The Measure App will function in simple **Meter mode** when you are not signed into the Loopworks portal. In **Meter mode**, your iOS device becomes the most accurate, dedicated field strength meter (FSM) currently available. To take advantage of the full range of online tools and functions, create an account at <https://loopworks.ampetronic.com>. To sign-in, press the Settings icon and the account will synchronise.

Signed in



Field Strength

A broad band measurement to measure field strength delivered by the system.

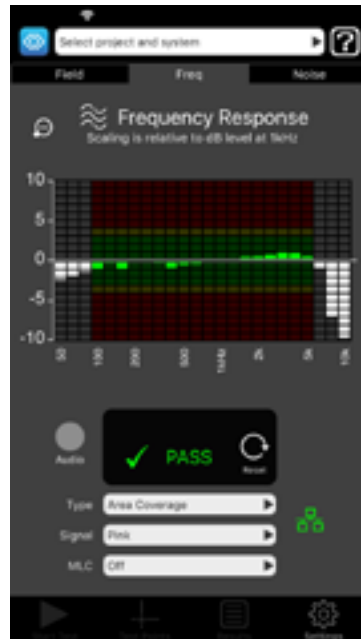

Frequency Response

Third octave filters for measuring performance across required frequency spectrum.



Background Noise

Determine level of background magnetic field present in the intended location for the loop system.

Signed out



Field Strength

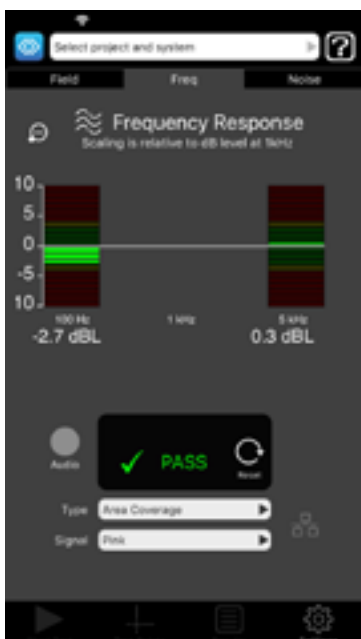

Frequency Response



Background Noise

Meter Mode - Field Strength

A broad band measurement to measure field strength delivered by the system. Select to measure un-weighted magnetic field strength.

- Broad band measurement 50Hz to 8kHz
- True RMS detection referenced to 400 mA/m
- Scale -40 to +10dBL or -15 to +6 dBL by pressing zoom
- Suitable for use with sine wave, pink noise, combination and live signals. Can also reference speech.
- Band pass filters to enable discrimination of the intended signal from background noise

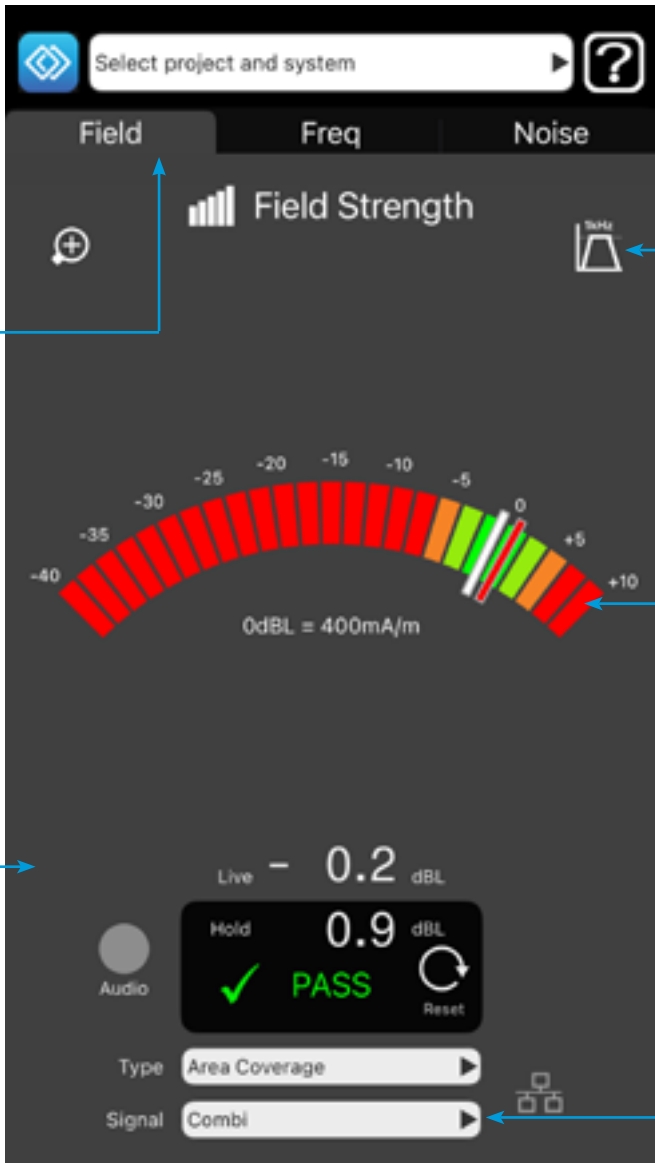

The screenshot shows the 'Field Strength' measurement interface. At the top, there is a 'Select project and system' dropdown and a help icon. Below this are three tabs: 'Field', 'Freq', and 'Noise'. The 'Field' tab is active, showing a 'Field Strength' bar graph and a 'Band Pass Filter' selector with options for '1KHz' and 'Flat'. A 'Dynamic Meter Display' is shown as a semi-circular scale from -40 to +10 dBL, with a needle pointing to 0.2 dBL. Below the scale, the text '0dBL = 400mA/m' is displayed. The 'Reading Reference' is shown as 'Live - 0.2 dBL' and 'Hold 0.9 dBL'. A green checkmark and 'PASS' indicator are visible. At the bottom, there is an 'Audio' button, a 'Type' dropdown set to 'Area Coverage', and a 'Signal' dropdown set to 'Combi'. A 'Reset' button is also present.

Meter Mode:
Field strength

Band Pass Filter:
1KHz or Flat

Dynamic Meter Display:
Field strength mode

Reading Reference
-40 to +10dB

Input Signal Selector

- Combi
- Pink
- Sine
- Live
- Reference for speech

Signed out

Meter Mode - Frequency Response

Third octave filters for measuring performance across the required frequency spectrum. Select to measure un-weighted frequency response of the magnetic field.

- Third octave bands at 100Hz, 1kHz and 5kHz
- True RMS detection
- Scale resolution to 1dB, measurements to 0.1dB
- For use with pink and combination signals.

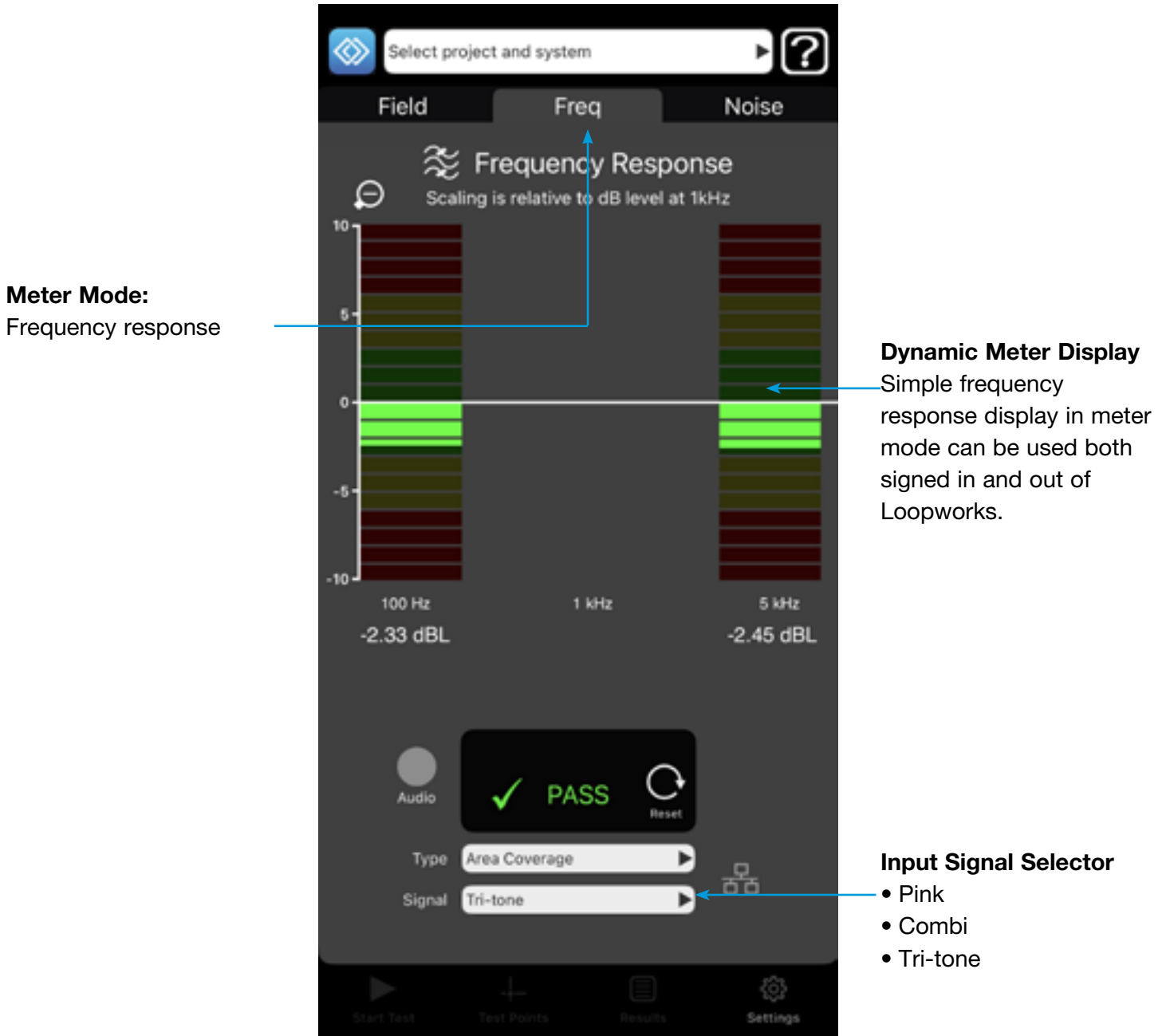

Signed out

Meter Mode - Background Noise

To determine the level of the background magnetic field present in the intended location for the loop system. Also used to measure low-level signals to assess overspill outside a loop system. Select to measure A-weighted magnetic field strength of unwanted signals.

- A-Weighted filter
- True RMS detection. 0dB referenced to 400mA/m
- Scale -60 to -0dBL or -45 to -15dBL
- Audio output can be captured for analysis in signed-in, certify mode or listened to live via the headphone jack in signed-out, Meter mode
- For use with system on or off, sine waves and combination signals.



The screenshot shows the 'Background Noise' interface in Meter Mode. At the top, there is a search bar 'Select project and system' and a help icon. Below are tabs for 'Field', 'Freq', and 'Noise', with 'Noise' selected. The main display features a semi-circular dynamic meter with a scale from -60 to 0 dB. The needle is positioned at -45.1 dB. Below the meter, it shows 'Live -45.1 dBL' and 'Hold -44.1 dBL' with a green checkmark and 'PASS' text. There are 'Audio' and 'Reset' buttons. At the bottom, there are dropdown menus for 'Type' (set to 'Area Coverage') and 'Signal' (set to 'System Off'). A bottom navigation bar includes 'Start Test', 'Test Points', 'Results', and 'Settings'.

Meter Mode:
Background noise

Dynamic Meter Display

- Changes to suit mode
- Live & peak indicators
- Advanced views

Reading Reference
-60 to -0dB

Alignment Alert

Input Signal Selector

- System off
- System on
- Combi
- Sine

Signed out



Getting Started: Setting up a project in the App

1. Define a Project

In order to start a new session, you will first need to define your project. To do this, first press the white projects bar at the top of the app. Open the Project selection control and press New. Fill in the project name and other details then press Done. Now you can select the newly created project from the list.

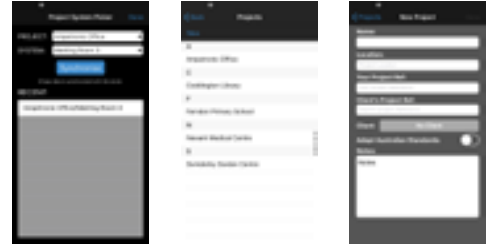

2. Define a System

Once you have defined your project, you will also need to define your system. To do this, open the System selection control and press New. Give the system a name and choose whether you are testing an area coverage loop or small volume service point. Press Done then select the newly created session from the list.



3. Synchronise with Loopworks™

If your device is online, Loopworks will automatically synchronise new records and data with the online portal as they are created. The projects page will tell you if there is any unsynchronised data and let you manually synchronise at any time. This is useful to do when first coming back online if tests have been carried out without an internet connection.

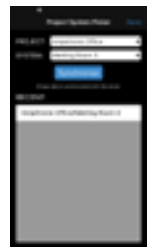

4. Define Test Points

Once you have synchronised your defined project and system with Loopworks, it's time to define your test points. Return to main meter screen and select test points. **See p13 of this user guide for more detail about defining test points.**



5. Start your Test Session

You're now ready to start your session, which you'll be prompted to name. You can choose from: Commissioning, Quick Check, Freestyle or Site Assessment tests or open an existing session. **All these steps are described in more detail in pages 15-25 of this user guide.**

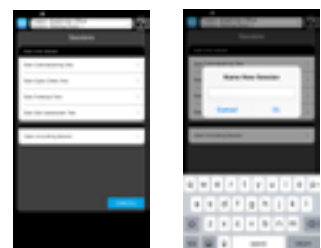

Test Mode

Once signed in to your Loopworks account, you can synchronise your data with the Loopworks online portal by using the Project menu, making it possible for you, or a colleague, to record and analyse results. In Test mode, you will also have access to step-through guides that walk users through the processes of collecting site data, performing system checks, commissioning systems to Standard and creating test and certification reports.

Once signed in, we advise users to stay signed in to access all the step-through guides, even without internet access. You should synchronise your data with the portal when you reconnect. **See previous page for more guidance on syncing in the Project menu.**

Start freestyle test:

Select to evaluate the functional performance of a system against IEC 60118-4

Start site assessment test:

Select to evaluate a site using a simple test loop

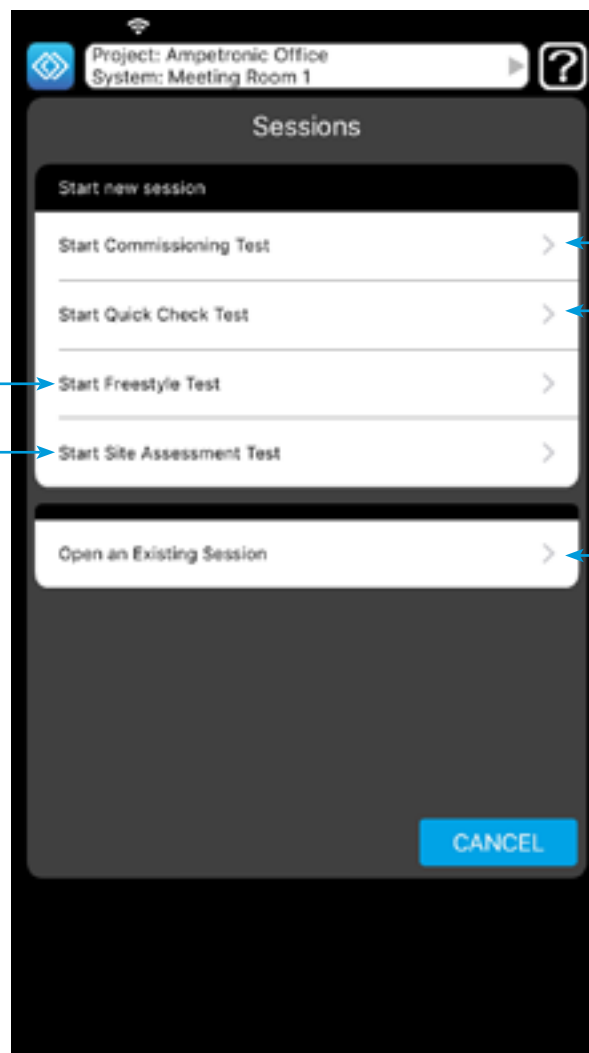

Start new

commissioning test:

Select to evaluate the complete performance of a system against IEC 60118-4 for certification

Start quick check test:

Select to perform a basic evaluation of a system against IEC 60118-4

Open and review an existing session

Test Mode - Commissioning Test

Select Start a New Commissioning Test to evaluate the complete performance of a system against IEC 60118-4 for certification. Users can also create test and certification reports, including the full commissioning test report, in the online tools.

To carry out a commissioning test you will need access to and control of the amplifier in order to play the specified test signals and make adjustments to settings.

See <https://www.youtube.com/user/AmpetronicLoops> for a full demonstration of commissioning with LW Measure.

NOTE: Make sure you follow the guidance regarding loop height and setting up test points on **pages 12 & 13**. You will be required to take measurement at each defined test point when measure except for overspill.

Steps 1-3



Background Noise

Test with system OFF.
Identify sources of magnetic noise within the area.
At least 4 test results are required.

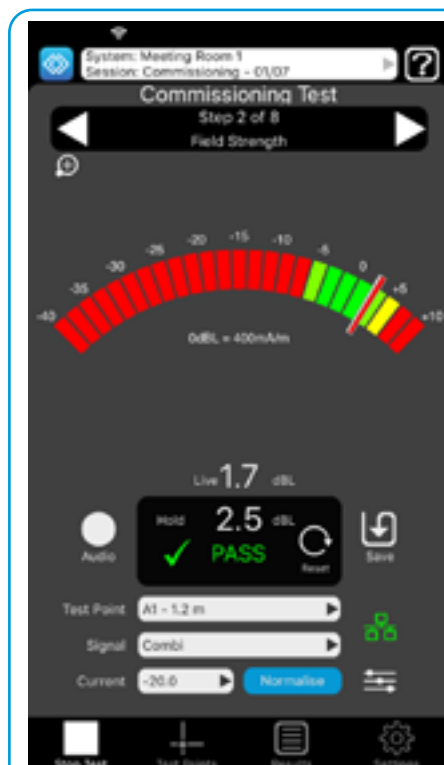

Field Strength

Test level with a COMBI signal
in at least one position.
Adjust output current on
amplifier.
At least 4 test results are
required.



Frequency Response

Test with PINK noise in at least
one position.
Adjust MLC control on
amplifier.
At least 4 test results are
required.

Steps 4-8



Live Listening

Use headphones to test signal presence, quality and clarity with live signal.



Field Strength test with Live Signal

Test level in at least one position with intended audio source.

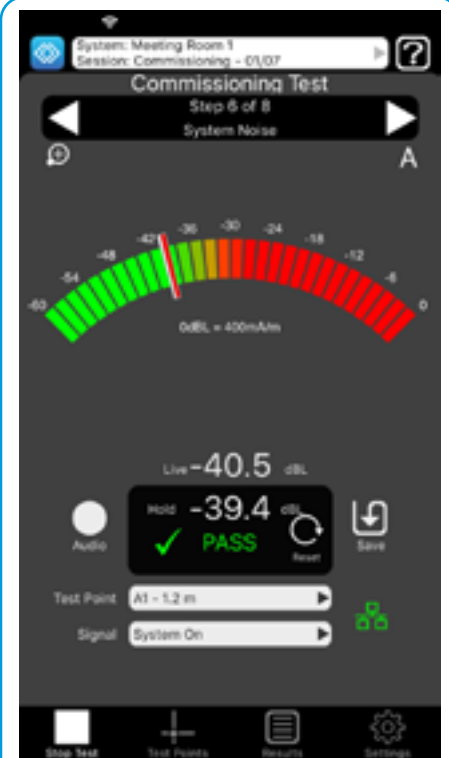

System Noise test

Test in at least one position with system ON and inputs muted.



Overspill

If required, test room overspill with COMBI signal.



Venue Accessibility

Check for appropriate signage, trained staff and appropriate system maintenance.



Test Mode - Commissioning Test results in the Loopworks portal

Once users have created and signed in to their Loopworks account, the App will synchronise any collected data with the Loopworks online portal, making it possible for users to view, analyse and share their results online. Users can also create test and certification reports, including the full commissioning test report shown below.

The screenshot displays the Loopworks portal interface for a commissioning test. At the top, there are navigation tabs: 'Learn', 'Connect', 'Measure', and 'Design'. Below this is a 'SESSION SUMMARY' section with a table containing session details like 'Session date', 'Session name', 'Session type', and 'Testing engineer'. To the right of this table are buttons for 'Add Results' and 'View Data'. Below the summary is the 'SESSION RESULTS' section, which shows a 'Verdict: Commissioning' status with a checkmark. A table below this lists various test types with their results (Pass/Fail) and a 'Test Verdict' row. At the bottom, there are sections for 'Test Point Data' and 'Venue Accessibility', each with a table of test points, comments, and results. A 'Test Equipment' and 'Comment' field are also present at the bottom of the report.

Test point data
Click on each result to view detailed measurement data, play or download audio clips, or make changes when in edit mode.

Venue Accessibility data

Manage and print your reports

Session status

Overall system verdict

Test types

Edit or manage your test points

Test Mode - Quick Check Test

Quick Check Test is designed for environments where quite simple, but perhaps multiple, hearing loop systems are pre-installed and a basic evaluation of the system against IEC 60118-4 is required. A good example of this type of scenario would be in a supermarket, where multiple counter loops are required. This test does not require test signals to be played through the loop system.

Steps 1-4



Background Noise

Test with system OFF.



Live Listening

Test signal presence, quality and clarity with live signal.



Live Signal

Test and record live signal in at least one position.

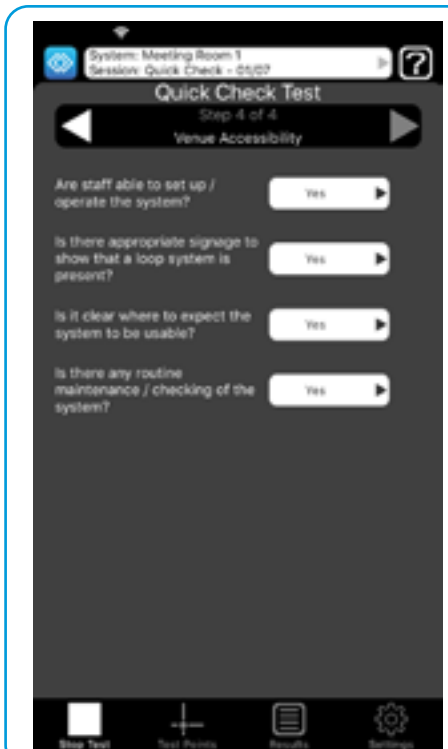

Venue Accessibility

Check for appropriate signage, trained staff and appropriate system maintenance.

NOTE: Make sure you follow the guidance regarding loop height and setting up test points on **pages 13 & 14**.



Test Mode - Quick Check Test Results in the Loopworks portal

Quick Check Test evaluates pre-installed systems against Standard. Users can compile, manage and print their system reports complete with their own company's logo via the online environment.

SESSION SUMMARY

Session date	01/07/2020	Test session notes	
Session name	Quick Check		
Session type	Quick Check		
Survey engineer	Chris Dale		

SESSION RESULTS

Verdict Quick Check

Test Point	Background Noise	Use Signal	Action
A - Music	✓	✓	View
B - Bell	✓	✓	View
C - Bell	✓	✓	View
D - Claret	✓	✓	View
Test Verdict	✓	✓	

Venue Accessibility

Question	Comments	Answer	Verdict
Does the input signal indicator (on amplifier) show a signal is present?		Yes	✓
Judge the loud (Fluor, bulb, or other signal that is not intended to be heard?		Clear	✓
Judge the quality of the signal, is there popping or ticking sounds alongside normal signals?		Clear	✓
Judge the signal clarity, e.g. is it dull, dull or muffled?		Clear	✓
Are the signals delivered without triggering slip detection on the loop object?		Yes	✓
Test Verdict			✓

Test Equipment: Measurements performed via Measure Test App

Comment:

Manage and print your reports

Test types

Edit or manage your test points

Test point data

Venue Accessibility data

Test Mode - Freestyle Test

Select Freestyle Test to evaluate the functional performance of a system against IEC 60118-4 by capturing results (not for certification). The Freestyle Test mode can be used to set up amplifiers and do site tests pre-installation, in preparation for commissioning.

Steps 1-6



Background Noise

Test with system OFF. Identify sources of magnetic noise within the area. At least 4 test results are required.



Field Strength

Test with a COMBI signal. Adjust output current on amplifier. At least 4 test results are required.

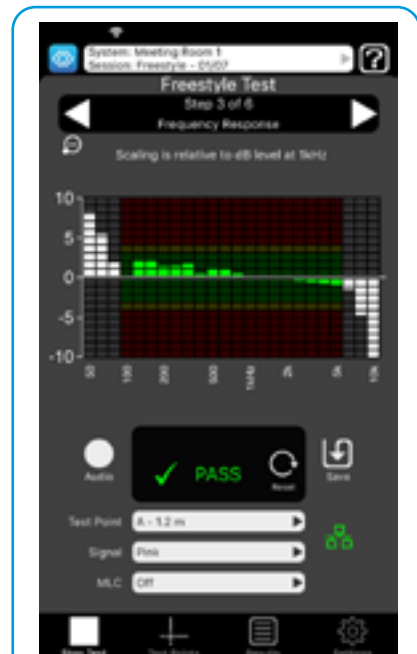

Frequency Response

Test with PINK noise in at least one position. Adjust MLC control on amplifier. At least 4 test results are required.



Field Strength test with Live Signal

Test level in at least one position with intended audio source.

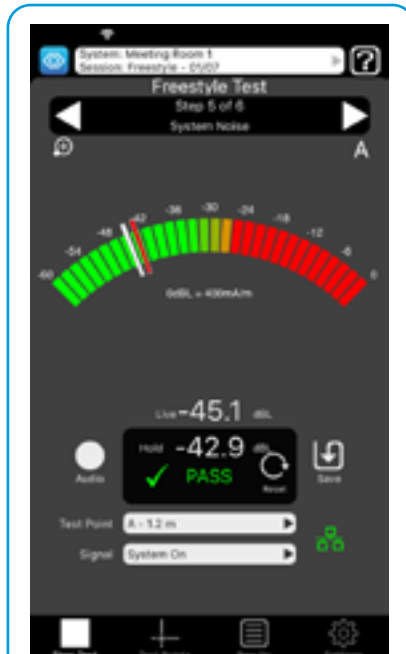

System Noise test

Test in at least one position with system ON and inputs muted.



Overspill

If required, test room overspill with COMBI signal.

NOTE: Ensure you follow the guidance regarding loop height and setting up test points on **pages 13 & 14**



Test Mode - Freestyle Test Results in the Loopworks Portal

Freestyle Test evaluates the functional performance of a system against Standards. Users can compile, manage and print their system reports complete with their own company's logo via the online environment.

SESSION SUMMARY

Session date	05/07/2020	Test session notes	
Session name	Freestyle		
Session type	Freestyle		
Survey engineer	Chris Dale		

SESSION RESULTS

Tested to Standard(s) IS09118-4

Verdict: Freestyle ✓

Test Point	Background Noise	Field Strengths	Frequency Response	User Signal	Churn/B	System Noise	Actions
A...Noise	✓	✓	✓	✓	-	✓	REVIEW
B...Sig	✓	✓	✓	✓	-	✓	REVIEW
C...Sig	✓	✓	✓	✓	-	✓	REVIEW
D...Center	✓	✓	✓	✓	-	✓	REVIEW
E...Churn/B	-	-	-	-	✓	-	REVIEW
Test Verdict	✓	✓	✓	✓	✓	✓	

Manual Test Points

Test Equipments: Measurements performed via Measure Tool App

Comments:

Manage and print your reports

Test types

Test point data

Edit or manage your test points

Test Mode - Site Assessment Test

Select Site Assessment Test to evaluate a site using a simple test loop and capture results to determine the most suitable type of installation and specific amplifier required.

Results from Site Assessment Tests can be analysed and used alongside Loopworks Design to ensure accurate specification of the most cost effective installation for your project. Note that this is the only test type where we are not looking to achieve a pass result, purely measure the loop performance with a known current. Any test loop should closely resemble the intended final installation.

Use alongside an Ampetronic HLS-2D Metal Loss Test Driver for easy and portable site testing. For more information on conducting site tests, see the videos on our YouTube channel.

Steps 1-4



1. Test Loop Details

ARMS, length, width, height, gaps and construction.



2. Field Strength

Test with a COMBI signal.

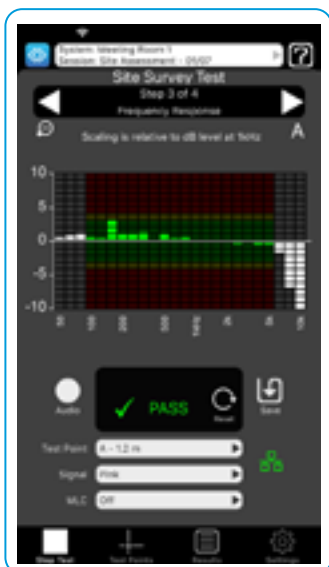

3. Frequency Response

Test with PINK noise.



4. Background Noise

Test with system OFF.

Be aware that background noise may change in the final installation if the test is being carried out on a construction site.



Test Mode - Site Assessment Test Results in the Loopworks Portal

Site Assessment Test evaluates a site using a simple test loop in order to understand the type of system needs to be installed. Users can compile, manage and print their system reports complete with their own company's logo via the online environment.

SESSION SUMMARY

Session date	03/01/2020	Test session notes	
Session name	Site Assessment		
Session type	Site Assessment		
Survey engineer	Chris Dale		

SESSION RESULTS

Tested to Standard(s): BS EN 118-4
Test type: A site scan to reveal test result areas.

Test Point	Background Noise	Field Strength	Frequency Response	Action
Link to image	✓	✓	✓	Download
Link to image	✓	X	✓	Download

Test Loop Data

Loop current in Ah/ks	25
Length of the loops	4
Width of the loops	2
Loop height	0
Gap between the loops	0.5
Construction Type	Steel Reinforced Concrete (In-situ)

Test Equipment: Measurements performed via SiteScan Tool App

Comments:

Manage and print your reports

Test types

Edit or manage your test points

Test point data

Test loop data



Test Mode: Editing a Project or System in the Portal



1. Create or edit a Project or System

You can create and edit projects and systems in the Loopworks Measure portal as well as in the App. This facility gives users the option to create and edit systems pre site visit, on site and post site visit. Users can also open and review projects in the portal; once sessions are in review, users will lose the option to make any more measurements in the session via the App.

You are able to add or change comments and answers, exclude results or convert them to qualified passes, however you cannot edit the actual measurement level data recorded via the app. To change this you must re-take the measurement on site.

Once all edits have been made press 'Issue & Closed' to put the session into a final read-only state, ready to print a report.

2. Managing Test Points

You can manage all of your test points directly via the Loopworks Measure Portal. This is particularly useful if you have defined test points ahead of a site visit and wish to make edits.

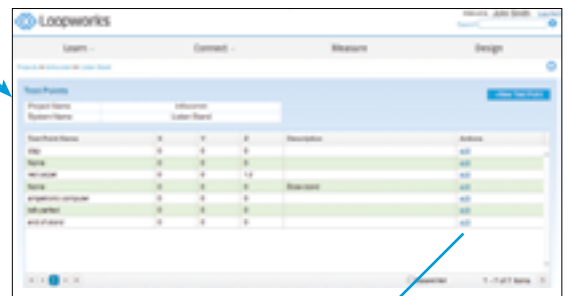

3. Add or Edit Test Points

Each test point is captured in the Loopworks Measure Portal; by clicking on individual test points, a dialogue box appears that gives users the option to add or edit test point measurements.

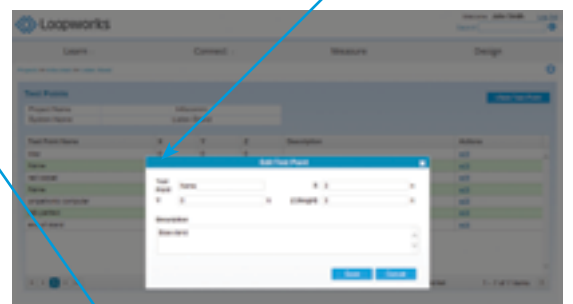

4. Edit Test Points Data

You can add test point comments and descriptions and edit data for your test points by clicking directly into the test point results. You can also choose to include or exclude a test point from your final results; although by selecting this option, you will lose the option to make any more measurements in the session via the App.



Each meter view shows a clear pass, qualified pass or fail verdict live on screen which updates in real time with the measurements you make. These verdicts are based around the requirements of the IEC 60118-4 performance standard. Colour coding of the meters indicate the different ranges which vary dependent on the test type and signal type that are currently active.

When in a test mode the results saved in each test point are collated to give a verdict for that specific section, and then an overall verdict for the system as a whole. You will need at least 4 test points with results saved against them to create a system verdict.

Knowing how verdicts are measured will give you the best chance of achieving a pass when commissioning your next hearing loop system. It's important to review your results whilst on site and understand the changes you can make to improve system performance before finishing any test.



The screenshot displays the 'Loopworks' software interface for 'AMPETRONIC'. The main content is a 'Hearing Loop Commissioning Test Certificate' for 'Project: Ampetronic Office'. The certificate includes a table of test results and an overall system verdict.







Installation details		Testing details	
Customer: Loopworks	Project: Ampetronic Office	Company: Ampetronic Ltd	Test Equipment: Measurements performed on Measure test app
System: Hearing Room 1	System Type: New	Tested by: J. Lee (Loop)	Date: 20/01/2017
Description:		Location: Commissioning	

Overall System Verdict
Does the system deliver against the requirements of the standard? **PASS**

Test Point	Test Name	Requirement	Result
1	Background Noise	Are levels of interference or noise acceptably low?	<input checked="" type="checkbox"/>
2	Field Strength	Are acceptable field levels achieved throughout the area?	<input checked="" type="checkbox"/>
3	Frequency Response	Does the system achieve acceptable frequency response throughout the area?	<input checked="" type="checkbox"/>
4	Use Signal Listening Test	Does the input signal indicator on amplifier show a signal is present?	<input checked="" type="checkbox"/>
		Judge the level of hum, buzz, or other signal that is not intended to be heard?	<input checked="" type="checkbox"/>
		Judge the quality of the signal, is there popping or ticking sounds alongside normal signals?	<input checked="" type="checkbox"/>
		Judge the signal clarity, e.g. is it clear, dull or muffled?	<input checked="" type="checkbox"/>
		Are test signals delivered without triggering clip detection on the loop driver?	<input checked="" type="checkbox"/>
5	Use Signal Final Check	Does the system achieve acceptable field strength with test signals?	<input checked="" type="checkbox"/>
6	System Noise	Does the system achieve acceptably low noise levels with the signals included?	<input checked="" type="checkbox"/>
7	Overcall	Are the overcall levels acceptable?	<input checked="" type="checkbox"/>
8	Visual Accessibility	Is there appropriate signage to show that a loop system is present?	<input checked="" type="checkbox"/>
		Is it clear where to expect the system to be visible?	<input checked="" type="checkbox"/>
		Are staff able to set up / operate the system?	<input checked="" type="checkbox"/>
		Is there any routine maintenance / checking of the system?	<input checked="" type="checkbox"/>

Declaration that the system has been tested against the requirements of BS6118:4:2014:2015-2017. **Signed:** **Date:**

The following table shows the requirements for each test verdict and how these contribute to an overall commissioning test result.

Commissioning verdicts guide		Individual test verdicts			
		Pass	Qualified pass	Fail	Notes
 Background noise		-32dB or below	Above -32dB up to -22dB	Above -22dB	
	Area coverage	From -3dB to +3dB	*From -4.5dB to +4.5dB	* Below -4.5dB or above +4.5dB	
 Field strength	Service point	From -6dB to +6dB	From -7.5dB to +7.5dB	Below -7.5dB or above +7.5dB	
	Frequency response	100Hz to 5kHz within ±3dB of 1kHz	100Hz or 5kHz within ±6dB of 1kHz and 125Hz to 4kHz within ±3dB of 1kHz	100Hz or 5kHz more than ±6dB from 1kHz or 125Hz to 4kHz more than ±3dB from 1kHz	
 Live listening	Input signal?	Yes	No	N/A	
	Hum/buzz?	Quiet	Noticeable	Very noisy	
	Quality?	Clean	Noticeable	Distorted	
	Clarity?	Clear	Noticeable	Unclear	
	No clipping?	Yes	Clips, audio OK	Clipping	
 Live field strength	Area coverage	From -6dB to +3dB	From -9dB to +6dB	Below -9dB or above +6dB	
	Service point	From -6dB to +3dB	From -9dB to +8dB	Below -9dB or above +8dB	
 System noise		-47dB or below, or within 3dB of background noise test	Above -47dB up to -32dB, if more than 3dB above background noise	Above -32dB, if more than 3dB above background noise	
	Overspill	-32dB or below, or within 3dB of background noise test	Above -32dB up to -22dB, if more than 3dB above background noise	Above -22dB, if more than 3dB above background noise	
 Venue accessibility	Signage?	Yes	N/A	No	
	Where used?	Yes	No	N/A	
	Trained staff?	Yes	N/A	No	
	Maintained?	Yes	No	N/A	

Overall verdicts:

Pass = all sections are passes, will still pass if overspill and venue accessibility have no verdict.

Qualified pass = one or two sections are qualified passes, can still qualified pass if live listening, overspill and venue accessibility have no verdict.

Fail = any section is failed or three or more sections are qualified passes.

*Selecting Australian standards, with metal present for the commissioning session, will increase field strength qualified pass window for area coverage systems to -9dB to +6dB.

[†] Different limits apply to field strength tests for other signals

Section verdict			
Pass	Qualified pass	Fail	Notes
All tests pass	Up to 50% of tests qualified pass	Any test fails or more than 50% of tests qualified pass	Test signal: system off At least four tests are required
All tests pass, at least one result is between 0dB and +3dB	Up to 50% of tests qualified pass	Any test fails or more than 50% of tests qualified pass	Test signal: combi or sine At least four tests are required
All tests pass	Any test qualified pass	Any test fails	Test signal: pink noise At least four tests are required
All answers as pass	Up to 50% of answers qualified pass	Any answer fails or more than 50% of answers qualified pass	Test signal: live signals To achieve an overall verdict of pass, this section must pass
All tests pass	Up to 50% of tests qualified pass	Any test fails or more than 50% of tests qualified pass	Test signal: live signals Only one test is required
All tests pass	Any test qualified pass	Any test fails	Test signal: system on, no signal Only one test is required
All tests pass	Any test qualified pass	Any test fails	Test signal: combi or sine No overspill test is required for overall verdict
All answers as pass	Up to 50% of answers qualified pass	Any answer fail or more than 50% of answers qualified pass	Leaving any questions as 'no answer' will not affect overall verdict

The Loopworks R2 can be used as an induction loop receiver by enabling listening mode:

- To check an induction loop system is working. It is useful for venue managers, test engineers and event organisers.
- To check the extent of induction loop coverage.
- To check if a proposed installation has excessive (magnetic) background noise prior to installing the loop system.

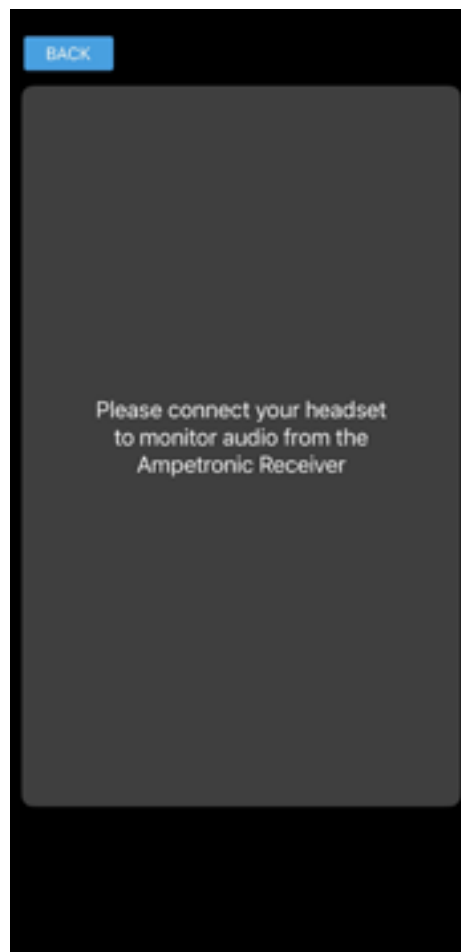
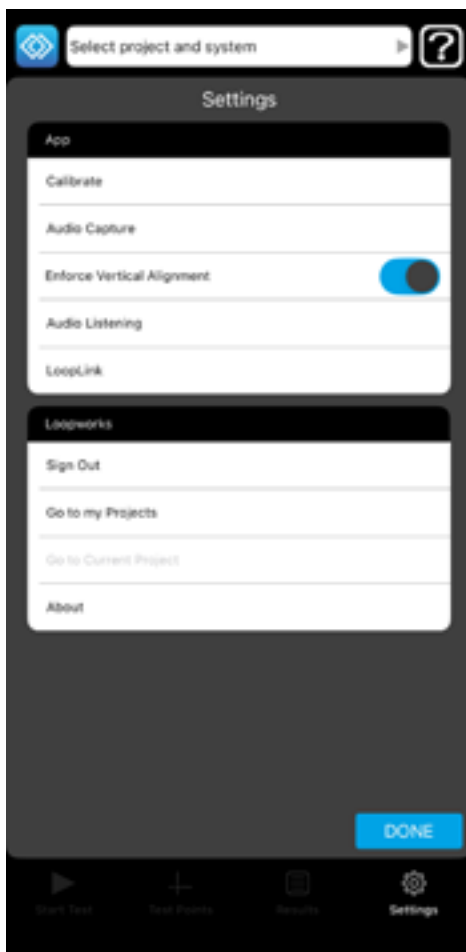

1. Select settings then tap on audio listening

2. Connect headset to the 3.5mm jack plug on the Loopworks R2

3. Locked screen allows audio to continue and the Loopworks R2 to be used as an induction loop receiver

1. Receiver does not calibrate

- You may not have accepted the option to allow Loopworks permission to use the microphone input found in **Settings > Privacy > Microphone > Loopworks Measure**



2. I can't capture meter reading

- Have you signed in?
- Ensure you're using the App in the correct alignment
- Assign a test point/create a test point when signed in.



Alignment!



3. How do I start a test?

- Make sure you are signed in to your Loopworks account
- Ensure that you have selected/defined a project and system prior to starting a test
- Ensure you have defined a Test Point (or Test Points) to save the data against.



4. I'm stuck in a Session! How do I get out?

- Press the **Stop Test icon**
- If it not selectable, then use the **forward arrow** to move on to a stage when the test can be stopped/paused.



5. I can't sign in, what do I need to do?

- Make sure you have signed up for a Loopworks account at <https://loopworks.ampetronic.com> and that you have received the email confirming that it has been set up. Ensure you have access to a wireless network when signing into Loopworks.

6. The App won't synchronise with my Loopworks account, what do I need to do?

- You need to have access to a wireless network when signing into Loopworks. If the App is taking a long time to synchronise, then you may be in an area with poor Wi-Fi signal. If you are signed in, you can use the App to store data locally and synchronise later
- If the App is taking a long time or failing to synchronise, then you may be using a network with firewall settings that is preventing the connection. If you are signed in, you can use the App to store data locally and synchronise later.

7. How do I make the Record Audio button selectable?

- You need to have designated a test point and be in **Test mode** to record audio against.

Important Safety Information

Misuse Disclaimers

WARNING: Failure to follow these safety instructions could result in fire, electric shock, injury, or damage to iPhone, iPad or other property. Read all the safety information below before using device.

Handle iOS device with care. It is made of metal, glass, and plastic and has sensitive electronic components inside. iPhone or iPad can be damaged if dropped, burned, punctured, or crushed, or if it comes in contact with liquid. Don't use a damaged device, such as one with a cracked screen, as it may cause injury. If you're concerned about scratching, consider using a case or cover.

Repairing

Don't open iPhone or iPad and don't attempt to repair device or Receiver yourself. Disassembling device may damage it or may cause injury to you. If device or Receiver is damaged, malfunctions, or comes in contact with liquid, contact Apple or an Apple Authorised Service Provider, or, in the case of damage to the Receiver, Ampetronic.

Battery

Don't attempt to replace the device battery yourself—you may damage the battery, which could cause overheating and injury. The lithium-ion battery in device should be replaced only by Apple or an Apple Authorised Service Provider, and must be recycled or disposed of separately from household waste. Don't incinerate the battery. For information about battery recycling and replacement, go to apple.com/batteries/replacement-and-recycling.

Distraction

Using iPhone or iPad in some circumstances may distract you and might cause a dangerous situation (for example, avoid using headphones to record audio when on a busy construction site). Observe rules that prohibit or restrict the use of mobile devices or headphones.

Do not use these services while performing activities that require your full attention. Always comply with posted signs and the laws and regulations in the areas where you are using device and always use common sense.